



Ferre Aceros Metálicos de Matamoros

Presentación de Marcas 2023

famma.mx

emy.zamarripa@famma.mx



SELLOS DE SEGURIDAD PARA RESGUARDAR Y CONTROLAR MATERIALES, CON CERTIFICADO CT-PAT



- Sellos de correa metálica
- Sellos de bola
- Sellos de cable de acero
- Sellos de plástico
- Sellos electrónicos
- Sellos de horquilla



famma.mx



emy.zamarripa@famma.mx



(868) 1010 683



VALVULAS INDUSTRIALES DE IMPORTACIÓN.



- Válvulas de bola
- Válvulas de globo
- Válvulas Mariposa
- Válvulas check
- Dispositivos de contraflujo
- Válvulas de aguja
- Válvulas de alivio y seguridad
- Válvulas mezcladoras

- Válvulas de compuerta
- Válvulas termostáticas
- Actuadores
- Filtros para tuberías



 famma.mx

 emy.zamarripa@famma.mx

 (868) 1010 683



CONEXIONES, MANGUERAS y ACCESORIOS NEUMÁTICOS



- Coples y conectores
- Conexiones de bronce
- Accesorios para llantas
- Manómetros
- Filtros trio
- Pistolas de aire
- Accesorios neumáticos y de aire. (tubing).



famma.mx



emy.zamarripa@famma.mx



(868) 1010 683



EQUIPO DE PROTECCIÓN PERSONAL

- Guantes de látex, nitrilo, vinil, carnaza, hule, para altas temperaturas, para químicos, insulados, para soldador y piel.
- Mangas de polietileno
- Cubre zapatos
- Cofias

- Cofias para el cabello
- Delantales
- Lentes de protección



famma.mx



emy.zamarripa@famma.mx



(868) 1010 683



MATERIAL DE GRADO INDUSTRIAL

- Adhesivos, tecnología y abrasivos
- Automotriz
- Diseño y construcción
- Manufactura
- Transporte

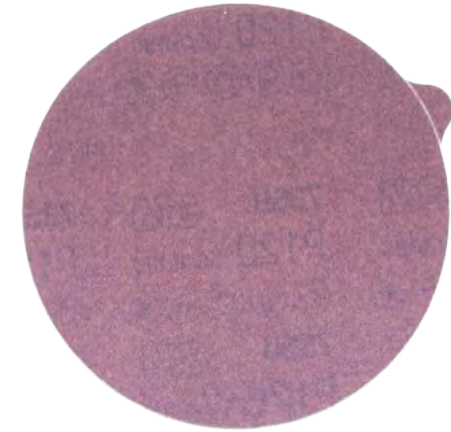

famma.mx



emy.zamarripa@famma.mx



(868) 1010 683

Bussmann®

PROTECCIÓN DE CIRCUITOS



- Fusibles industriales
- Doble elemento
- Ultra rápidos
- Porta fusibles
- Fusibles de vidrio
- Par alta tensión



famma.mx



emy.zamarripa@famma.mx



(868) 1010 683

VIKON® CONDUCTORES ELÉCTRICOS



- Alambres y cables desnudos
- Alambres y cables para alta tensión
- Alambres magnéticos
- Alambres de control
- Cables para distribución aérea y subterránea
- Transformadores Prolec

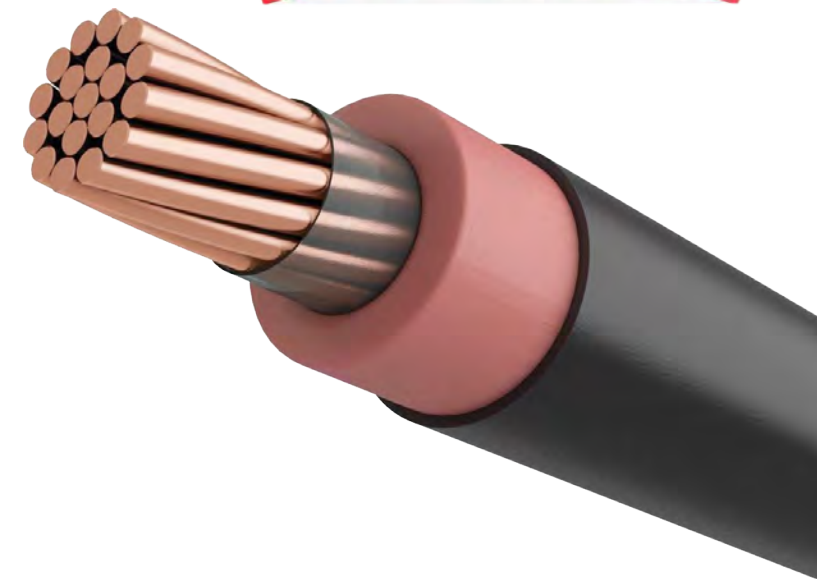

famma.mx



emy.zamarripa@famma.mx



(868) 1010 683

RAWELT®

INSTALACIONES ELECTRICAS EN ÁREAS PELIGROSAS Y CORROSIVAS.



- Cajas ovales y RR
- Tubos rígidos de aluminio
- Lámparas y reflectores led a prueba de intemperie y explosión
- Semáforos industriales
- Cajas de registro a prueba de explosión
- Sellos para áreas peligrosas



famma.mx



emy.zamarripa@famma.mx



(868) 1010 683



CINTAS INDUSTRIALES



- Para empaque
- Eléctricas
- Doble capa
- Masking tape
- Antiderrapante
- Dedal
- Aluminio
- Delimitadora
- Para ductos



famma.mx



emy.zamarripa@famma.mx



(868) 1010 683

URREA

HERRAMIENTAS DE CALIDAD SUPERIOR

HERRAMIENTAS COMERCIALES E INDUSTRIALES.



- Equipos hidráulicos
- Compresores
- Cortadoras de concreto
- Sierras
- Pulidores
- Herramientas manuales
- Línea neumática
- Equipo de protección personal.



famma.mx



emy.zamarripa@famma.mx



(868) 1010 683



HERRAMIENTAS COMERCIALES E INDUSTRIALES.



- Bombas periferias
- Cajas para herramientas
- Cardas
- Carretillas
- Generadores eléctricos
- Moto sierras
- Palas, picos, etc.



famma.mx



emy.zamarripa@famma.mx



(868) 1010 683



MATERIAL ELECTRICO



- Brochas
- Material neumático
- Herramientas de corte industrial
- Fijación
- Adhesivos
- Herramientas manuales
- Material eléctrico
- Abrasivos



famma.mx



emy.zamarripa@famma.mx



(868) 1010 683

ARGOS



SUJECCIÓN, AUTOMATIZACIÓN Y ELECTRICIDAD



- Accesorios para tuberías
- Artefactos
- Audio y video
- Centros de carga
- Conductores
- Iluminación
- Soldadura
- Tubería pvc

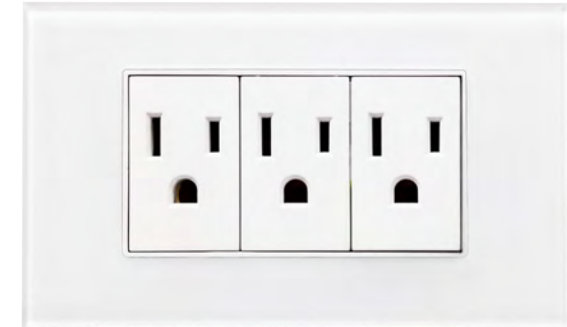

famma.mx



emy.zamarripa@famma.mx



(868) 1010 683



CONSUMIBLES Y MATERIAL DE EMPAQUE



- Cintas (metálicas, invisibles, decorativas, automotriz, alta temperatura y de oficina).
- Etiquetas (laser, blancas y de color)
- Notas adhesivas
- Forros y micas
- Cintas industriales

- Cintas industriales (Para empaque, Flejadora, para ducto, de laminación, para piso).
- Despachadores y maquinas encintadoras.
- Burbutek (Poli burbuja)
- Filltek (relleno de polietileno)
- Foamtek (Película de polietileno)
- Termotek Ultra (película estirable calibres 60 y 75).



famma.mx



emy.zamarripa@famma.mx



(868) 1010 683



EXPERTOS SELLADORES



- Poliuretano
- Acrílicos
- Butilo industrial
alta temperatura



famma.mx



emy.zamarripa@famma.mx



(868) 1010 683

industrade

HIDRATACIÓN PROFESIONAL

BEBIDAS HIDRATANTES PARA LA INDUSTRIA



- Fit sin azúcar
- Industrade con azúcar
- Presentación de 20 lts, 1 ltr y .600 ml-Fresa, Limón, uva y naranja



famma.mx



emy.zamarripa@famma.mx



(868) 1010 683



SOLUCIONES EN SOLDADURA



- Soldadura y corte
- Generadores eléctricos
- Soldadura mecanizada
- Sistemas robóticos
- Consumibles



famma.mx



emy.zamarripa@famma.mx



(868) 1010 683



HERRAMIENTAS DE CORTE MECANIZADAS



Procesos para la industria
metalmecánica:

- Barrenado
- Fresado
- Roscado
- Tronzado y ranurado
- Escareado



famma.mx



emy.zamarripa@famma.mx



(868) 1010 683



SAINT-GOBAIN

MATERIALES ABRASIVOS



- Lijas
- Discos para corte y desbaste
- Ruedas, puntas montadas, Piedras.
- Productos de fibra
- Productos de diamante
- Super abrasivos

- Limas rotativas
- Cintas adhesivas
- Cepillos
- Equipo de protección personal

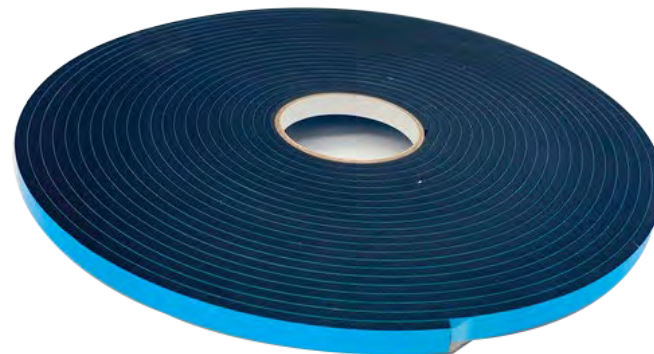

famma.mx



emy.zamarripa@famma.mx



(868) 1010 683

The Makita logo is displayed in white, italicized font on a teal rectangular background.

HERRAMIENTAS DE PODER E INTELIGENTES



- Herramientas inalámbricas
- Litio-ion
- Tecnología brushless
- Herramientas con conectividad Bluetooth
- Accesorios,
- Abrasivos, perforación, corte y desbaste



famma.mx



emy.zamarripa@famma.mx



(868) 1010 683

DURACELL®

Energizer®

BATERIAS



- Baterías AA, AAA, D, C, etc.
- Cargadores



famma.mx



emy.zamarripa@famma.mx



(868) 1010 683

LOCTITE®

ADHESIVOS INDUSTRIALES



- 243 Fijador de roscas resistencia removible
- 262 Fijador de roscas resistencia permanente
- 263 Fijador de roscas resistencia permanente
- 271 Fijador de roscas resistencia alta
- 277 Fijador de roscas resistencia alta

- 567 Sellador PTFE alta temperatura
- 609 Compuesto retenedor propósito general
- 680 Compuesto retenedor alta resistencia
- 495 Adhesivo instantáneo super bonder
- 454 Adhesivo instantáneo Prism



famma.mx



emy.zamarripa@famma.mx



(868) 1010 683

- Resinas Epoxi de uno, dos componentes y modificadas
- Cianocrilatos o instantáneos
- Polímeros MS
- Poliuretanos dos componentes
- Curado ultra violeta

- Acrílicos estructurales
- Selladores
- Aceleradores, imprimadores, activadores y disolventes.



famma.mx



emy.zamarripa@famma.mx



(868) 1010 683

CROSS LINE^{MR}

MATERIAL DE SUJECION

- Abrazaderas
- Codos y cople
- Ductos y accesorios
- Rieles y unicanales
- Conectores
- Bandejas/charolas
- Tubería
- Electro registros
- Rejillas

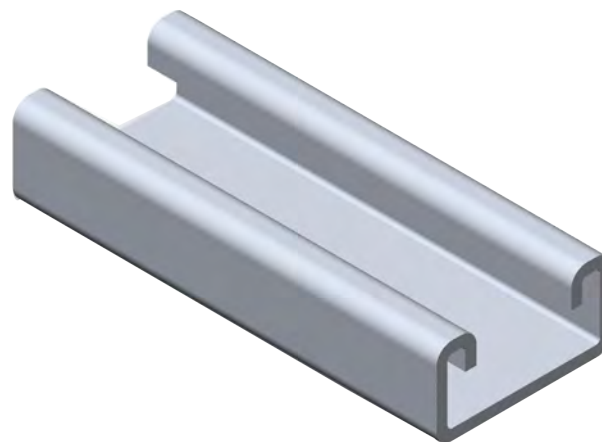
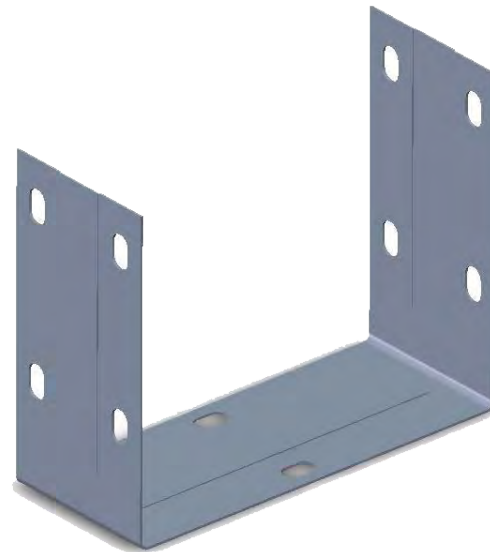

famma.mx



emy.zamarripa@famma.mx



(868) 1010 683



MILBANK[®]
ENERGY AT WORK

BASES PARA MEDIDORES



- Bases para medidores 5 x100, 7 x 100 y 7 x 200
- Gabinetes
- Pedestales
- Bases para servicios
- Dispositivos principales de medición



famma.mx



emy.zamarripa@famma.mx



(868) 1010 683

Mueller Co.

CONEXIONES Y TUBERIAS



- Tubería de cobre, negra, galvanizada.
- Valvulería
- Pegamentos y soldadura
- Conexiones de gas, galvanizadas, hierro, hierro maleable

- Productos para plomería, ventilación, aire acondicionado y refrigeración.
- Cespoles y Contracanas



famma.mx



emy.zamarripa@famma.mx



(868) 1010 683



CONEXIONES Y TUBERIAS



- Tubería rígida y flexible de cobre
- Conexiones de cobre
- Conexiones de bronce
- Válvulas de bronce
- Soldadura de estaño



famma.mx



emy.zamarripa@famma.mx



(868) 1010 683

SLOAN®

CONEXIONES Y TUBERIAS



- Fluxómetros
- Sanitarios
- Lavabos
- Mingitorios ecológicos
- Llaves
- Despachadores de jabón

- Cebolletas
- Secadores de mano
- Control del agua
- Accesorios
- Diafragmas



famma.mx



emy.zamarripa@famma.mx



(868) 1010 683

Master Lock®

CANDADOS Y DISPOSITIVOS DE SEGURIDAD



- Laminados
- De combinación
- Safety rojo
- Zinc arco
- De acero solido

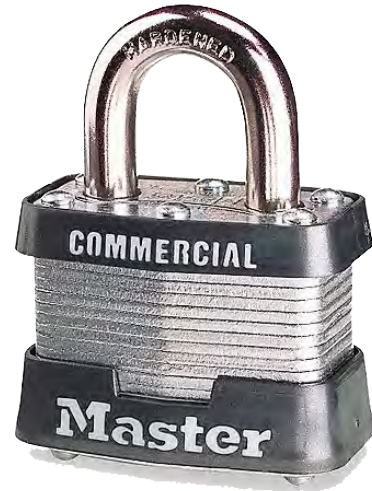

famma.mx



emy.zamarripa@famma.mx



(868) 1010 683

ARMADA BANMEJOR

CALZADO INDUSTRIAL



- Casquillo poliamida
- Antiderrapantes
- Ejecutivos
- Dieléctricos



famma.mx



emy.zamarripa@famma.mx



(868) 1010 683



BROCHAS Y PRODUCTOS



- Brochas
- Rodillos
- Extensiones
- Charolas
- Filtros de papel
- Estopa
- Espuma
- Aplicadores para epoxicos
- Abrasivos

- Compresores
- Pistolas para Pintar
- Hidro lavadoras
- Aerosoles
- Cintas
- Escaleras



famma.mx



emy.zamarripa@famma.mx



(868) 1010 683



PEGAMENTOS Y SELLADORES



- Silicones
- Selladores epoxicos
- Resanadores para madera
- Pegamento para PVC y CPVC



famma.mx



emy.zamarripa@famma.mx



(868) 1010 683

SOLVENTES Y MATERIA PRIMA

- Thinner
- Alcohol isopropílico y etílico
- Aguarrás
- Hipoclorito de sodio
- Sosa caustica
- Acetona
- Etanol toleno
- Ácidos

- Diesel
- Fosfatos
- Aminas
- Neutralizantes
- Sulfatos
- Cloruros
- Cetonas
- Aceites
- Emulsiones y resinas



SUAVIZADOR PARA AGUA



famma.mx



emy.zamarripa@famma.mx



(868) 1010 683



SISTEMA DE IMPERMEABILIZACIÓN



- Impercaucho 12 AÑOS
- Impercaucho 7 AÑOS
- Resanador



famma.mx



emy.zamarripa@famma.mx



(868) 1010 683



DIVISION DE HIGIENE INDUSTRIAL



- Lustra-pisos
- Gel antibacterial
- Aserrín tratado
- Limpiador multiusos tipo fabuloso
- Desengrasantes alcalinos
- Aromatizantes
- Shampoo para mano

- Limpiador de vidrios tipo Windex
- Armor all
- Cloro
- Covikill19
- Desengrasantes base solvente o industrial



famma.mx



emy.zamarripa@famma.mx



(868) 1010 683

GCPaper

Institucional

- Toalla interdoblada
- Toalla en rollo para manos

Papel higiénico de bobina :

- Jumbo
- Junior

COMSUMIBLES HIGIENICOS



famma.mx



emy.zamarripa@famma.mx



(868) 1010 683



MANGUERAS, CONEXIONES Y ACCESORIOS



- Mangueras de PVC, poliuretano para succión, descarga de alimentos y materiales industriales
- Mangueras y tubos de PVC con o sin refuerzo de malla textil o espiral de acero



famma.mx



emy.zamarripa@famma.mx



(868) 1010 683

YANKON

ISB[®]
SOLA BASIC

ILUMINACIÓN

Plusrite[®]
ilumina tu futuro

S
SUPRALUX

FAMMA
Ferre Aceros Metálicos de Matamoros

- Barras fluorescentes y led
- Panel slim
- Luminarios para sobreponer
- Reflectores led
- Luminarios para vialidades o estacionamientos

- Wallpacks
- Spots
- Sistemas
- Fotovoltaicos
- Tecnología Wireless
- Reflectores para estadio



famma.mx



emy.zamarripa@famma.mx



(868) 1010 683

KLEIN TOOLS, INC.



HERRAMIENTAS INDUSTRIALES PARA ELECTRICISTAS PROFESIONALES



- Pinzas
- Herramientas para telecomunicaciones
- Peladores, cortadores y ponchadoras
- Herramientas aisladas

- Juegos de herramientas
- Porta herramientas
- Bolso
- Cinturones y tirantes
- niveles y
- Herramientas de medición
- Llaves



famma.mx



emy.zamarripa@famma.mx



(868) 1010 683



GRIFERIA Y VÁLVULAS

- Llaves
- Válvulas
- Herrajes
- Llaves mezcladoras
- Regaderas



famma.mx



emy.zamarripa@famma.mx



(868) 1010 683



HERRAMIENTAS INDUSTRIALES



- Rodajas
- Candados tipo cortina,
- Termoplásticos de bloqueo,
- Portacandados para bloqueo
- Cadenas
- Cable de acero
- Garruchas
- Roda cargas

- Hidráulicos
- Anclas
- Cintas
- Cortadores
- Verticales
- Broqueros
- Machuelos y brocas de cobalto
- Buriles
- Navajas
- Limas rotativas y bastardas
- Cardas



famma.mx



emy.zamarripa@famma.mx



(868) 1010 683



ACCESORIOS PARA BAÑO Y PLOMERIA



- Herrajes
- Contracanas
- Mangueras alimentadoras
- Cespos



famma.mx



emy.zamarripa@famma.mx



(868) 1010 683



TORNILLERIA



- Socket
- Acero inoxidable
- Flat
- Botton
- Hexagonal
- Opresores
- Tuercas
- Arandelas
- Pernos sólidos y perforados



famma.mx



emy.zamarripa@famma.mx



(868) 1010 683



HERRAMIENTAS COMERCIALES



- Luminarios led
- Ventiladores
- Caretas electrónicas
- Destornilladores
- Linterna recargables
- Extensiones



famma.mx



emy.zamarripa@famma.mx



(868) 1010 683



MATERIAL ELÉCTRICO COMERCIAL



- Centro de cargas
- Interruptores termo magnéticos
- Cajas registro
- Ductos
- Bases para medidor
- Tableros de distribución



famma.mx



emy.zamarripa@famma.mx



(868) 1010 683



CONEXIONES Y ACCESORIOS



- Abrazaderas
- Válvulas
- Conexiones CPVC-PVC, gas.
- Grifería para WC
- Mangueras
- Tarjas y accesorios



famma.mx



emy.zamarripa@famma.mx



(868) 1010 683

ALTAMIRA

BOMBAS Y EQUIPOS HIDRONEUMÁTICOS



- Arrancadores y tableros de control
- Bombas sumergibles para pozo profundo
- Motores sumergibles rebobinables

- Bombas sumergibles para drenaje
- Bombas multietapas verticales



famma.mx



emy.zamarripa@famma.mx



(868) 1010 683



BOMBAS Y EQUIPOS HIDRANEUMATICOS



- Arrancadores y tableros de control
- Bombas sumergibles para pozo profundo
- Motores sumergibles rebobinables

- Bombas sumergibles para drenaje
- Bombas multietapas verticales



famma.mx



emy.zamarripa@famma.mx



(868) 1010 683

GRUPO



MATERIALES ABRASIVOS



- Discos de corte
- Hojas y almohadillas
- Limas rotativas
- Brocas y ruedas perfiladoras
- Cepillo flap
- Líquido enfriador
- Sierras metálicas
- Cepillos de alambre

- Copas y conos Abrasivos
- Discos de Lija autoadherible
- Sets de discos de diamante
- Lijadora neumática orbital
- Bandas

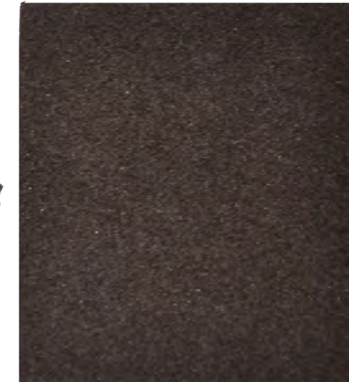

famma.mx



emy.zamarripa@famma.mx



(868) 1010 683



EQUIPO DE PROTECCIÓN PERSONAL



- Malla plástica
- Postes con base negra
- Gorros de malla
- Tapones auditivos desechables
- Chaleco rescatista
- Guantes anticorte
- Cubre bocas
- Casco industriales

- Respiradores N95
- Arneses
- Retráctiles
- Cinturones de seguridad
- Accesorios antiestáticos



famma.mx



emy.zamarripa@famma.mx



(868) 1010 683



MATERIAL ELÉCTRICO



- Conectores de alimentación
- Conectores de conexión a tierra y vinculación. desechables
- Herramientas
- Terminales
- Perchas para cables
- Herramientas para bridas de cables

- Compresión de cobre
Terminales y Empalmes

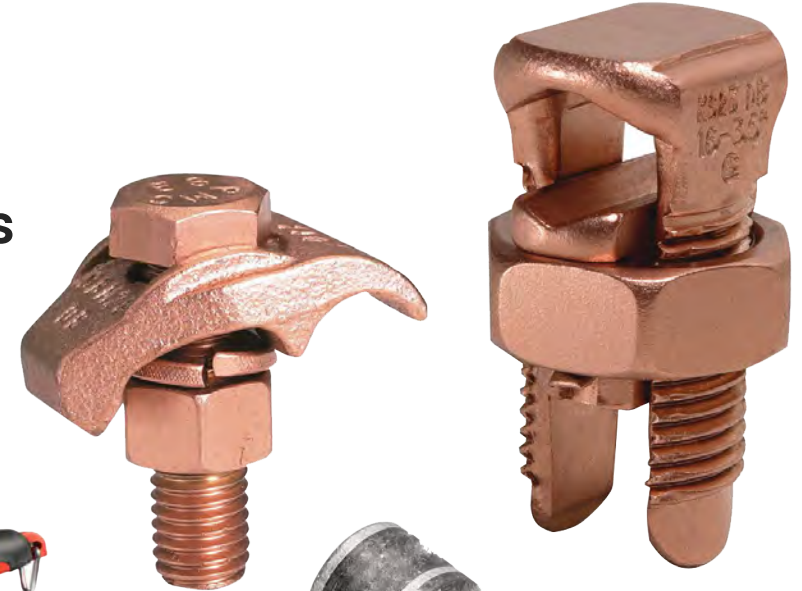

famma.mx



emy.zamarripa@famma.mx



(868) 1010 683



Energía eléctrica, iluminación y conectividad



- Artículos electrónicos
- Control S
- Conectores eléctricos
- Controladores de bombas contra incendios
- Controles de iluminación y sensores
- Iluminación comercial al aire libre
- Iluminación dura y peligrosa

- Dispositivos IP HUBBCOM™
- Inhibidores, ayudas de contacto y selladores
- Bastidores y cerramientos
- Audio y Video



famma.mx



emy.zamarripa@famma.mx



(868) 1010 683



ACEROS LARGOS, ALAMBRES Y ACEROS DE REFUERZO.



- Aceros de Refuerzo y Sistemas Constructivos
- Alambrón
- Varilla
- Castillo, Armadura, Escalerilla, Estribos
- Perfiles y Vigas Estructurales
- Perfiles Comerciales
- Mallas, Paneles y Cribas

- Cercos y Complementos
- Rejas, Vallas y Complementos
- Cadenas
- Clavos, Grapas y Complementos
- Cables y Retenidas
- Alambres y Semiflecha



famma.mx



emy.zamarripa@famma.mx



(868) 1010 683

SISTEMAS DE ALMACENAMIENTO HIDRÁULICOS

- Tinaco
- Cisterna
- Tanques industriales
- Biodigestor
- Tuberías PPR
- Accesorios

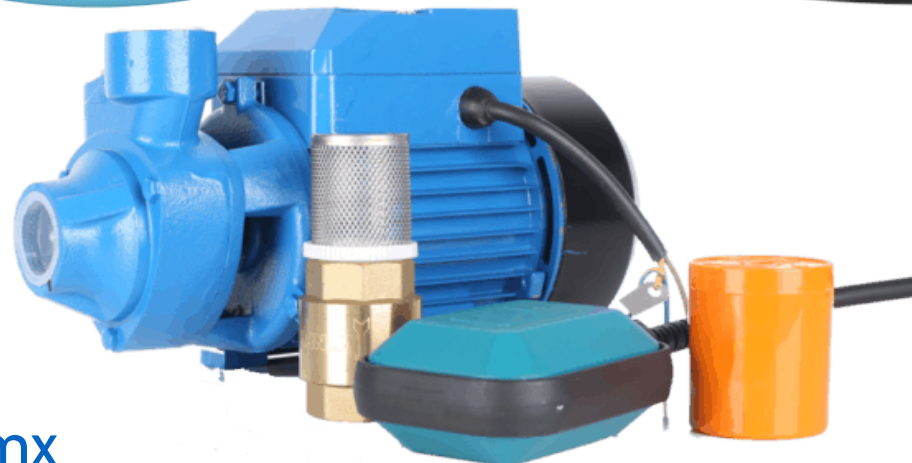

famma.mx



emy.zamarripa@famma.mx



(868) 1010 683

Pinturas para interiores y exteriores

- Para maderas
- Para pintar paredes y metal
- Impermeabilizantes para el mantenimiento del hogar
- Para el auto



famma.mx



emy.zamarripa@famma.mx



(868) 1010 683



Cerraduras y accesorios



- Cerraduras
- Candados
- Cerrojos
- Bisagras
- Accesorios para puerta



famma.mx



emy.zamarripa@famma.mx



(868) 1010 683

De igual manera me gustaría mencionarle nuestras políticas comerciales que, estamos seguros encontrara de mucho beneficio.



PRECIOS — Altamente competitivos.

CONOCIMIENTO — Ejecutivos de venta profesionales.

SERVICIO — 100% garantizado. Atención personalizada, eficaz y confiable.

SOPORTE TÉCNICO — En coordinación con nuestros fabricantes.

GARANTIA — Rápida y confiable.

TIEMPOS DE ENTREGA — Cortos, debido a nuestro gran almacén.

“EN ARTÍCULO ESPECIALES SE OFRECE ALMACÉN DIGITAL.”

 famma.mx

 emy.zamarripa@famma.mx

 (868) 1010 683